

1 Vorspannen - Vorausrichten:

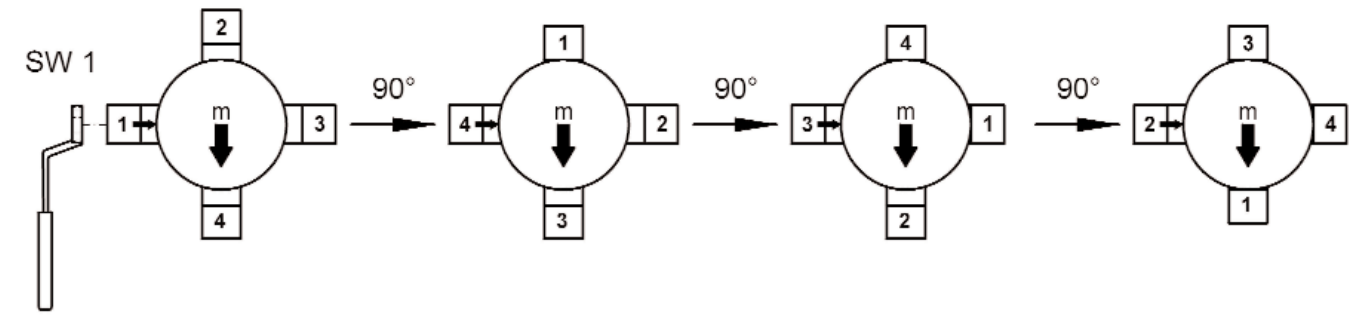

2 Kraftspannen - Feinausrichten
(außen + innen) SW 2 = SW 12

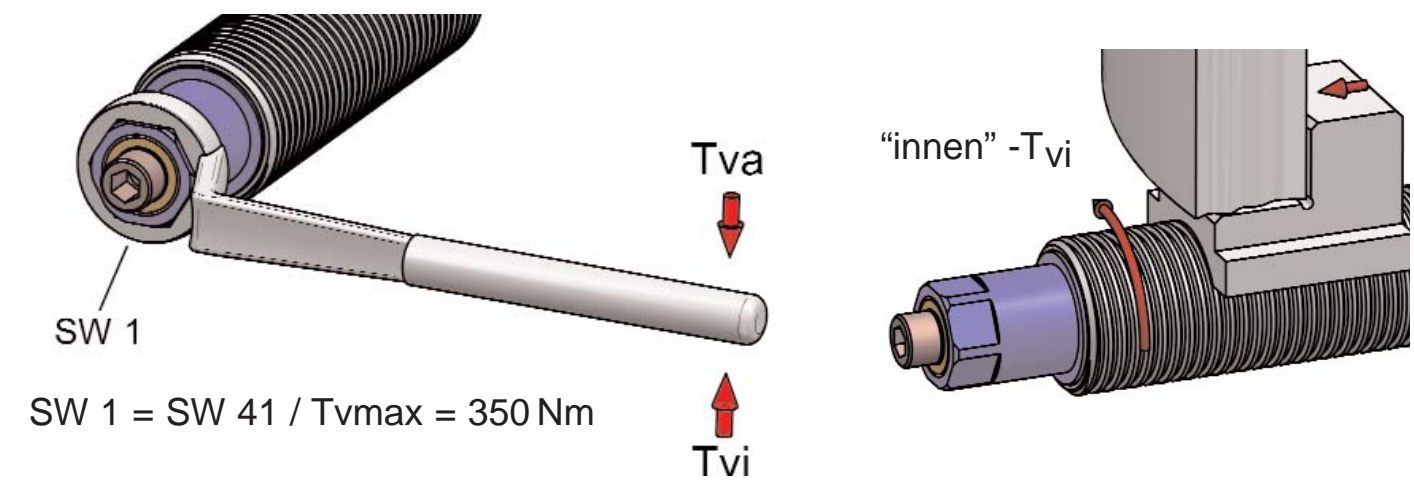
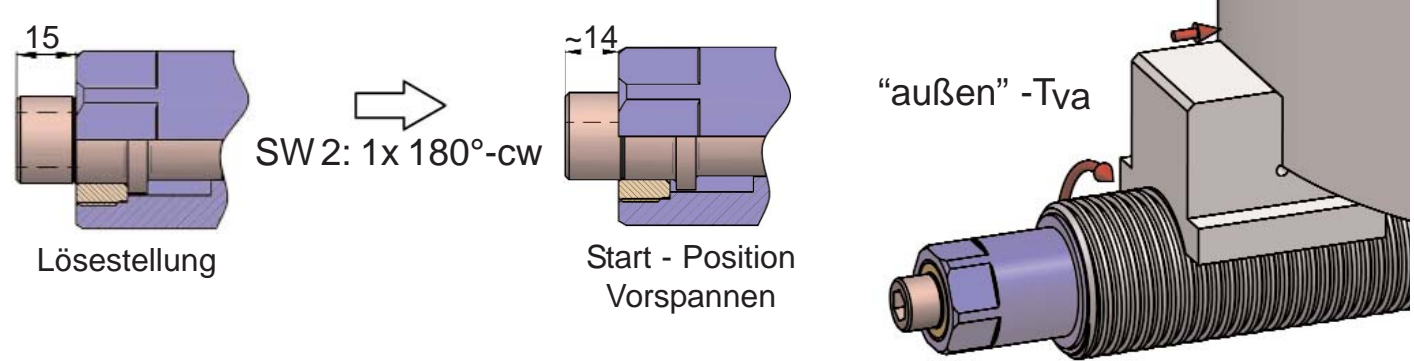
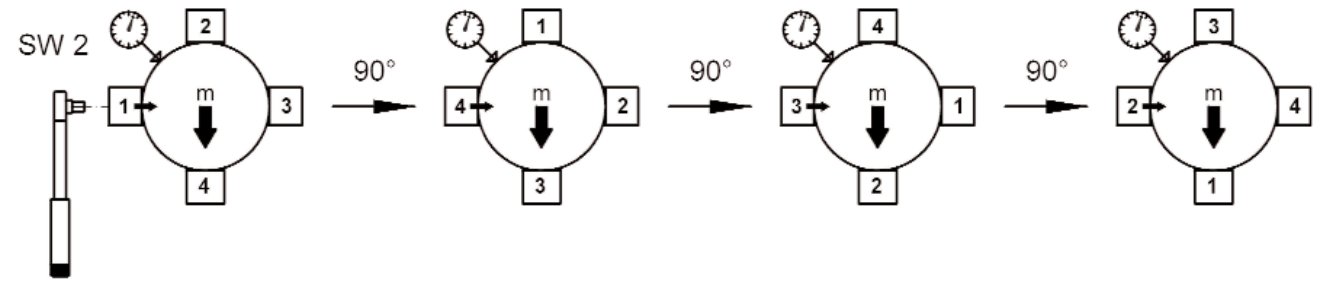
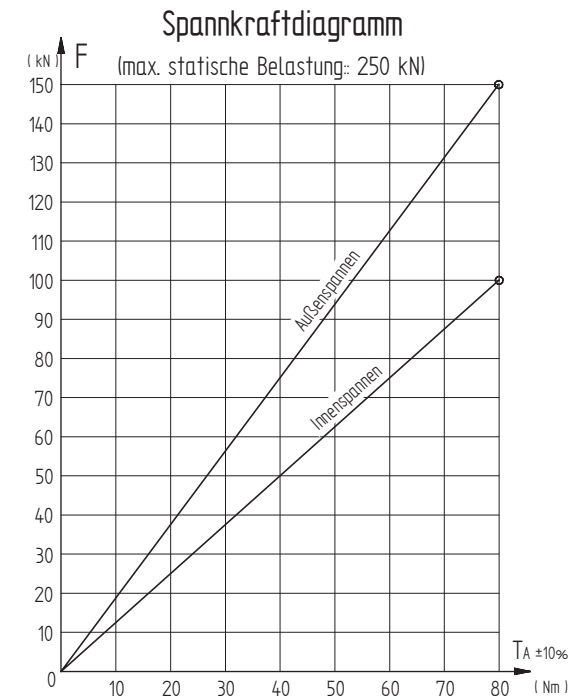
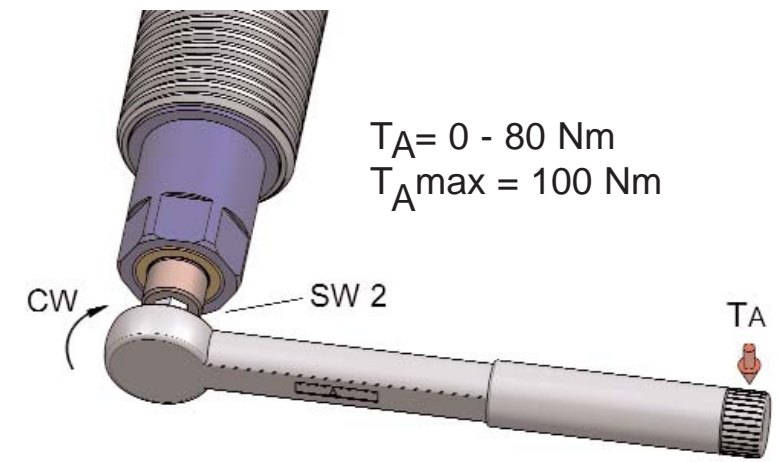

3 Spannhub - Kontrolle

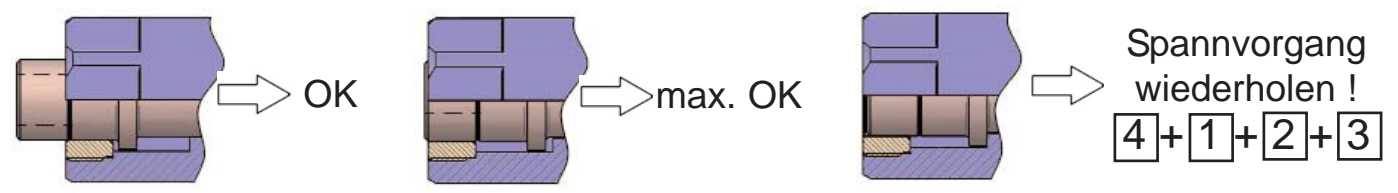

4 Lösen

4.1 Lösen - SW2



4.2 Lösen - SW1

